

## Accessoires de Levage

### *Lifting system*

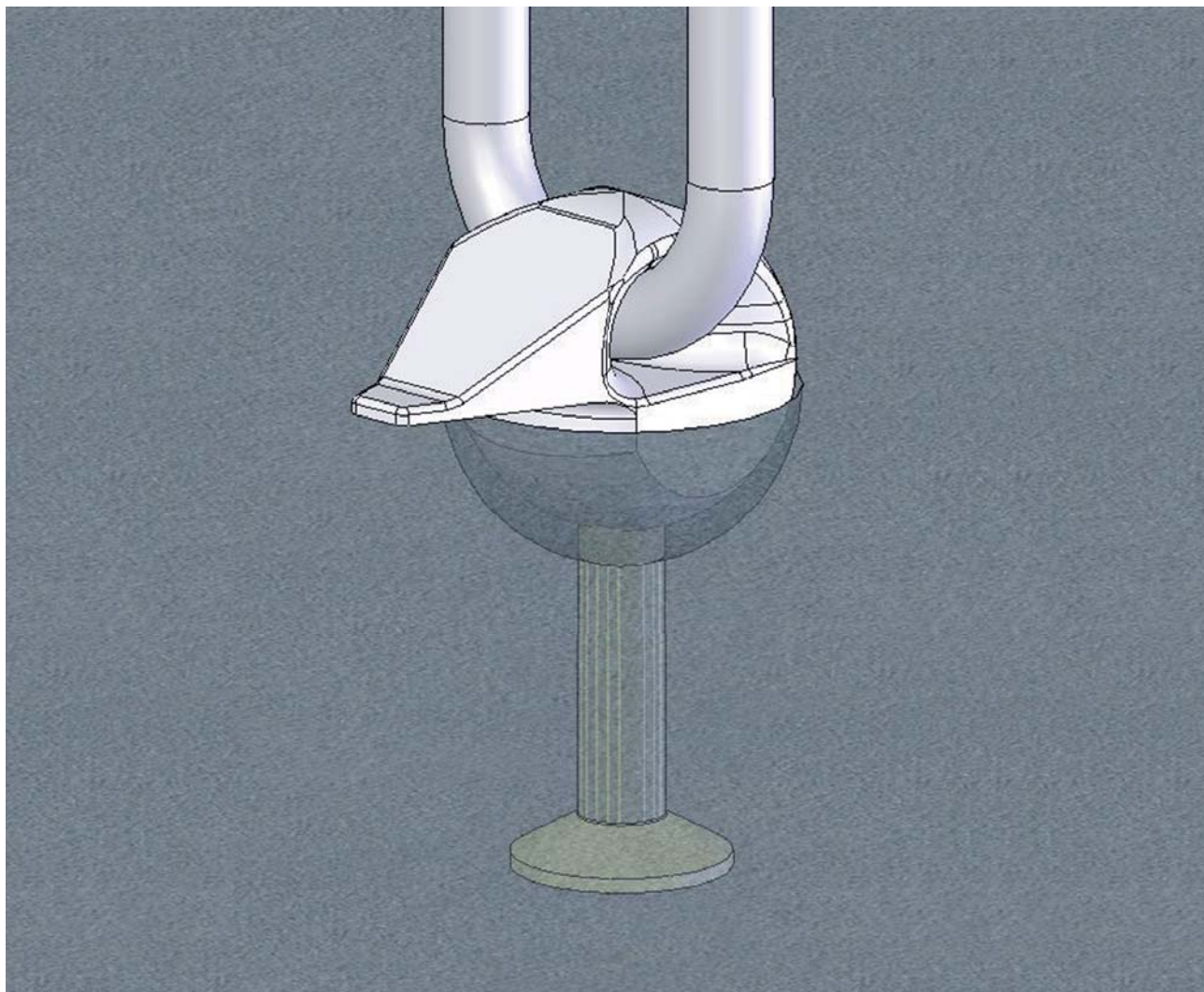
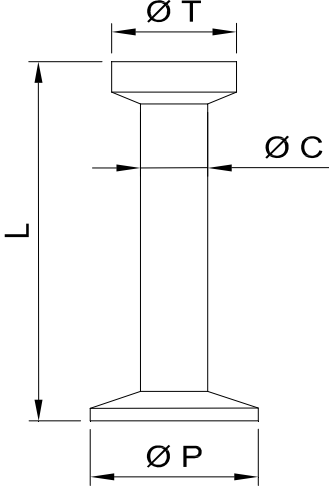
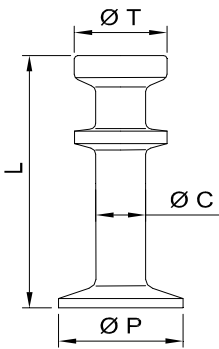
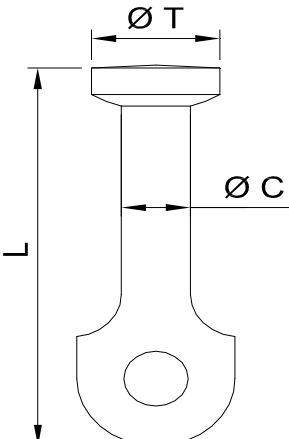

Accessoires accessories		1.3 T	2.5 T	5 T	7.5 T	10 T	15 T	20 T	32 T
<b>Ancre à Pied - AP</b> <b>foot anchor</b> 	Réf.	AP013...	AP025...	AP050...	AP075...	AP100...	AP150...	AP200...	AP320...
	ØT [mm]	18	25	36	46	46	69	69	88
	ØC [mm]	10	14	20	24	28	34	38	50
	ØP [mm]	25	35	50	60	70	85	98	135
	L [mm]	40 50 55 65 85 120 170 240	45 55 65 75 85 120 140 170 210 240 280	75 85 95 120 180 240 340	100 120 140 160 200 240 300	115 135 150 170 200 250 340	140 165 200 300 400	200 240 250 340 500	280 320 500 700
	<p>Les ancrs à pied peuvent être fournies en acier noir, électro-zingué (Z), ou galvanisé à chaud (G)  <i>The foot anchors can be provided black, electro zinc plated (Z) or hot dip galvanised (G).</i></p>								
<b>Ancre Magasin - AM</b> <b>double head anchor</b> 	Réf.	AM013...	AM025...	AM050...					
	ØT [mm]	18	25	36					
	ØC [mm]	10	14	20					
	ØP [mm]	25	35	50					
	L [mm]	55 65 85 120 240	55 65 85 120 240	120 180					

Accessoires accessories		1.3 T	2.5 T	5 T	7.5 T	10 T	15 T	20 T	32 T
<b>Ancre à Oeil - AO</b> <b>eye anchor</b> 	Réf.	AO130065	AO025090	AO050120		AO100180		AO200250	AO320300
	ØT [mm]	18	25	36		46		69	88
	ØC [mm]	10	14	20		28		38	50
	L [mm]	65	90	120		180		250	300
	G [kg]	0,06	0,16	0,40		1,16		3,17	6,34
	Réf.			AO050090		AO100115			
	ØT [mm]			36		46			
	ØC [mm]			20		28			
	L [mm]			90		115			
	G [kg]			0,35		0,82			

Les ancrs à pied peuvent être fournies en acier noir, électro-zingué (Z), ou galvanisé à chaud (G)  
 The foot anchors can be provided black, electro zinc plated (Z) or hot dip galvanised (G).

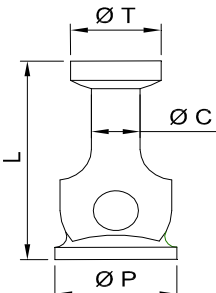
<b>Ancre à Oeil &amp; Pied - AOP</b> <b>foot &amp; eye anchor</b> 	Réf.	AOP013050	AOP02565	AOP050080					
	ØT [mm]	18	25	36					
	ØC [mm]	10	14	20					
	ØP [mm]	22	35	47					
	L [mm]	50	65	80					
	G [kg]	0,06	0,17	0,38					

Les ancrs à œil & pied peuvent être fournies en acier noir, électro-zingué (Z), ou galvanisé à chaud (G)  
 The foot & eye anchors can be provided black, electro zinc plated (Z) or hot dip galvanised (G).

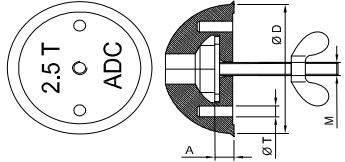
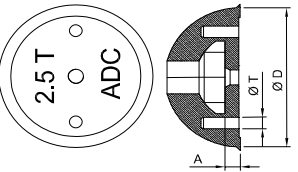
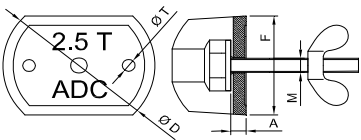
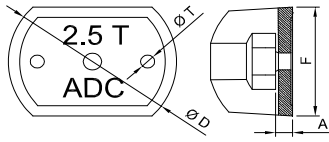
Accessoires accessories		1.3 T	2.5 T	5 T	7.5 T	10 T	15 T	20 T	32 T
<b>Réservation Elastomère Complète - REC</b> <i>complet rubber former</i> 	Réf.	REC013	REC025	REC050	REC075	REC100	REC150	REC200	REC320
	ØD [mm]	60	74	94	118	118	160	160	204
	ØT [mm]	6,5	6,5	8,5	10,5	10,5	10,5	10,5	10,5
	A [mm]	9	13	15,5	18	18	19	19	19
	M	M8	M10	M10	M12	M12	M12	M12	M12
	G [kg]	0,13	0,21	0,40	0,74	0,62	1,43	1,30	3,60
<b>Réservation Elastomère - RE</b> <i>rubber former</i> 	Réf.	RE013	RE025	RE050	RE075	RE100	RE150	RE200	RE320
	ØD [mm]	60	74	94	118	118	160	160	204
	ØT [mm]	6,5	6,5	8,5	10,5	10,5	10,5	10,5	10,5
	A [mm]	6	10	11,5	14	14	16	16	14
	G [kg]	0,08	0,16	0,29	0,54	0,42	1,19	1,06	3,4
<b>Réservation Elastomère Étroite Complète - REEC</b> <i>complet narrow rubber former</i> 	Réf.	REEC013	REEC025	REEC050		REEC100		REEC200	
	ØD [mm]	60	74	94		118		160	
	ØT [mm]	6,5	6,5	8,5		10,5		10,5	
	A [mm]	9	13	15,5		18		19	
	G [kg]	0,11	0,17	0,35		0,73		1,58	
<b>Réservation Elastomère Étroite - REE</b> <i>narrow rubber former</i> 	Réf.	REE013	REE025	REE050		REE100		REE200	
	ØD [mm]	60	74	94		118		160	
	ØT [mm]	6,5	6,5	8,5		10,5		10,5	
	A [mm]	6	10	11,5		14		16	
	G [kg]	0,06	0,12	0,24		0,53		1,34	

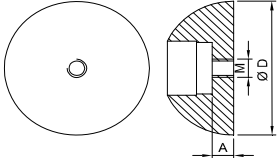
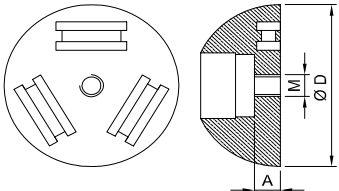
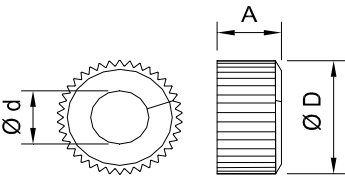
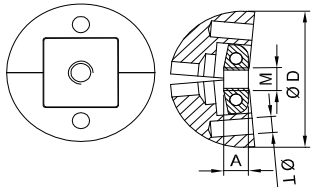
Accessoires accessories		1.3 T	2.5 T	5 T	7.5 T	10 T	15 T	20 T	32 T
<b>Réservation Acier - RA</b> <b>steel former</b> 	Réf.	RA013	RA025	RA050					
	ØD [mm]	60	74	94					
	A [mm]	5	8	10					
	M	M8	M12	M12					
	G [kg]	0,32	0,61	1,30					
<b>Réservation Magnétique - RM</b> <b>magnetic former</b> 	Réf.	RM013	RM025	RM050		RM100			
	ØD [mm]	60	74	94		118			
	A [mm]	6	9	12		12			
	M	M8	M10	M10		M10			
	Magnet [kg]	60	75	100		150			
G [kg]	0,11	0,20	0,36		0,58				
<b>Bague Contentive - BC</b> <b>rubber ring</b> 	Réf.	BC013	BC025	BC050		BC100			
	ØD [mm]	22	32	39		49			
	Ød [mm]	10	14	20		28			
	A [mm]	11	12	14		20			
G [kg]	0,01	0,01	0,02		0,04				
<b>Réservation Acier Articulé - RAA</b> <b>articulated steel former</b> 	Réf.	RAA013	RAA025	RAA050		RAA100			
	ØD [mm]	60	74	94		118			
	ØT [mm]	7	7	10		9			
	A [mm]	10	10	10		10			
	M	M10	M10	M10		M10			
	G [kg]	0,35	0,71	1,46		2,79			

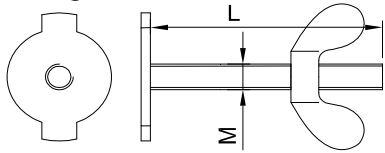
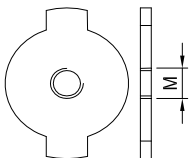
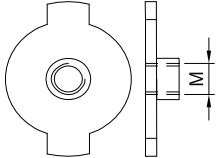
Accessoires accessories		1.3 T	2.5 T	5 T	7.5 T	10 T	15 T	20 T	32 T
<b>Ensemble de Fixation - EF</b> <i>fixing set</i> 	Réf.	EF013	EF025	EF050	EF100	EF100	EF200	EF200	
	M	M8	M10	M10	M12	M12	M12	M12	
	L [mm]	80	80	100	100	100	100	100	
	G [kg]	0,05	0,05	0,11	0,20	0,20	0,24	0,24	
<b>Plaquette Taraudée - PT</b> <i>threaded plate</i> 	Réf.	PT013	PT025	PT050	PT100	PT100	PT200	PT200	
	M	M8	M10	M10	M12	M12	M12	M12	
	G [kg]	0,01	0,02	0,04	0,05	0,05			
<b>Plaquette avec Ecrou - PE</b> <i>plate with bolt</i> 	Réf.	PE013	PE025	PE050					
	M	M8	M10	M10					
	G [kg]	0,01	0,02	0,04					

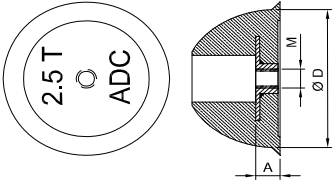
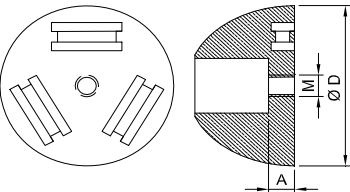
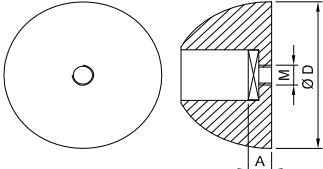
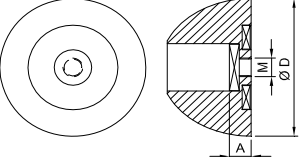
Accessoires accessories		1.3 T	2.5 T	5 T	7.5 T	10 T	15 T	20 T	32 T
<b>Réservation Contentive - RC</b> <b>tightening former</b> 	Réf.	RC013	RC025	RC050					
	Ø [mm]	60	74	94					
	A [mm]	9	11	14					
	M	M8	M10	M10					
	G [kg]	0,10	0,19	0,23					
<b>Réservation Contentive</b> <b>Magnétique - RCM</b> <b>magnetic tightening former</b> 	Réf.	RCM013	RCM025	RCM050					
	Ø [mm]	60	74	94					
	A [mm]	9	11	14					
	M	M8	M10	M10					
	Magnet [kg]	60	60	100					
G [kg]	0,15	0,20	0,25						
<b>Réservation à magnétisme</b> <b>Interieur - RI</b> <b>internal magnetic former</b> 	Réf.	RI013	RI025	RI050					
	Ø [mm]	60	74	94					
	A [mm]	9	11	14					
	M	M8	M10	M10					
G [kg]	0,45	0,88	1,60						
<b>Réservation à magnétisme</b> <b>Interieur, Magnétique - RIM</b> <b>internal and external</b> <b>magnetic former</b> 	Réf.	RIM013	RIM025						
	Ø [mm]	60	74						
	A [mm]	9	11						
	M	M8	M10						
G [kg]	0,45	0,88							

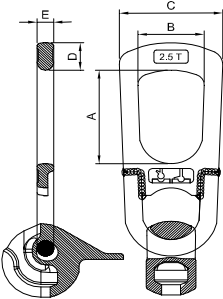
Accessoires accessories		1.3 T	2.5 T	5 T	7.5 T	10 T	15 T	20 T	32 T
<b>Anneaux - AN</b> <b>lifting eye</b> 	Réf.	AN013	AN025	AN050		AN100		AN200	AN320
	A [mm]	70	85	88		112		150	189
	B [mm]	46	58	70		84		118	175
	C [mm]	74	88	118		160		186	269
	D [mm]	20	25	37		50		75	100
	E [mm]	12	14	16		26		30	45
	G [kg]	0,89	1,62	3,18		9,70		26,20	45,80

## Notes

Les renseignements de cette documentation sont donnés à titre indicatif et peuvent être modifiés à tout moment, et et sans préavis par AdC.

*All information in this document is just indicative information, and can be modified without prior notification from AdC.*

Les ancrs peuvent être fournies en acier noir, électro-zingué (Z), ou galvanisé à chaud (G)

*The anchors can be provided black, electro zinc plated (Z) or hot dip galvanised (G).*

## Autres produits

### Douilles de levage

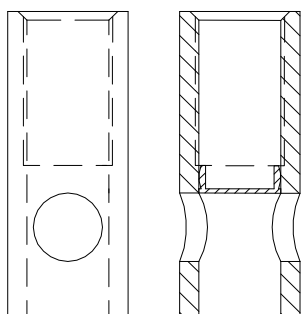

### Ligatures en fil d'acier

